

Dell FluidFS NAS Solutions NX3600/NX3610 Deployment Guide



Notes, Cautions, and Warnings



NOTE: A NOTE indicates important information that helps you make better use of your computer.



CAUTION: A CAUTION indicates either potential damage to hardware or loss of data and tells you how to avoid the problem.



WARNING: A WARNING indicates a potential for property damage, personal injury, or death.

© 2012 Dell Inc.

Trademarks used in this text: Dell™, the Dell logo, Dell Precision™, OptiPlex™, Latitude™, PowerEdge™, PowerVault™, PowerConnect™, OpenManage™, EqualLogic™, Compellent™, KACE™, FlexAddress™, Force10™ and Vostro™ are trademarks of Dell Inc. Intel®, Pentium®, Xeon®, Core® and Celeron® are registered trademarks of Intel Corporation in the U.S. and other countries. AMD® is a registered trademark and AMD Opteron™, AMD Phenom™ and AMD Sempron™ are trademarks of Advanced Micro Devices, Inc. Microsoft®, Windows®, Windows Server®, Internet Explorer®, MS-DOS®, Windows Vista® and Active Directory® are either trademarks or registered trademarks of Microsoft Corporation in the United States and/or other countries. Red Hat® and Red Hat® Enterprise Linux® are registered trademarks of Red Hat, Inc. in the United States and/or other countries. Novell® and SUSE® are registered trademarks of Novell Inc. in the United States and other countries. Oracle® is a registered trademark of Oracle Corporation and/or its affiliates. Citrix®, Xen®, XenServer® and XenMotion® are either registered trademarks or trademarks of Citrix Systems, Inc. in the United States and/or other countries. VMware®, Virtual SMP®, vMotion®, vCenter® and vSphere® are registered trademarks or trademarks of VMware, Inc. in the United States or other countries. IBM® is a registered trademark of International Business Machines Corporation.

2012 - 05

Rev. A00

Contents

| | |
|---|-----------|
| Notes, Cautions, and Warnings..... | 2 |
| 1 Overview..... | 5 |
| Setting Up The Environment..... | 5 |
| Selecting The Topology..... | 5 |
| MD Topology..... | 5 |
| Choosing The Switch Topology..... | 7 |
| Best Practice Solution In The HA Option..... | 8 |
| Dedicated SAN Solution In The Non-Redundant Option..... | 9 |
| All-In-One High-Availability Option..... | 10 |
| All-In-One Non-Redundant Option..... | 11 |
| Preparing Your Management Station..... | 12 |
| 2 Running The NAS IDU..... | 15 |
| Installing The NAS IDU..... | 15 |
| Launching The NAS IDU..... | 15 |
| Deploying The NAS Appliance Using The NAS IDU..... | 15 |
| 3 Setting Up Your MD Storage Solution..... | 19 |
| Creating Disk Groups..... | 19 |
| Creating Disk Groups Automatically..... | 19 |
| Creating Disk Groups Manually..... | 20 |
| Creating Virtual Disks..... | 21 |
| Creating A Host Group..... | 21 |
| Creating A Host..... | 22 |
| Adding Virtual Disks To A Host Group..... | 22 |
| Creating Host-To-Virtual Disk Mappings..... | 23 |
| Accessing The NAS Manager Web Interface..... | 23 |
| 4 NAS Manager Configuration Wizard..... | 25 |
| Configuring Additional Client VIPs..... | 28 |
| 5 PowerVault FluidFS NAS Setup Worksheet..... | 29 |
| 6 Getting Help..... | 31 |
| Contacting Dell..... | 31 |

Overview

Setting Up The Environment

To set up the environment:

1. Choose the topology and cable your solution.
2. Complete the NAS system setup worksheet.
See Appendix.
3. Prepare your management station.

 **NOTE:** Your solution requires a properly grounded electrical outlet, a compatible rack, and a rack installation kit. For information on installing the solution in the rack, see *Setting Up Your PowerVault Network Attached Storage Solution* that shipped with your product.

Selecting The Topology

Selecting the topology involves choosing the MD topology and the switch topology.

MD Topology

Your PowerVault MD32x0i array is equipped with eight iSCSI ports across two controllers. You can configure the MD32x0i array for your solution to serve both NAS and Block.

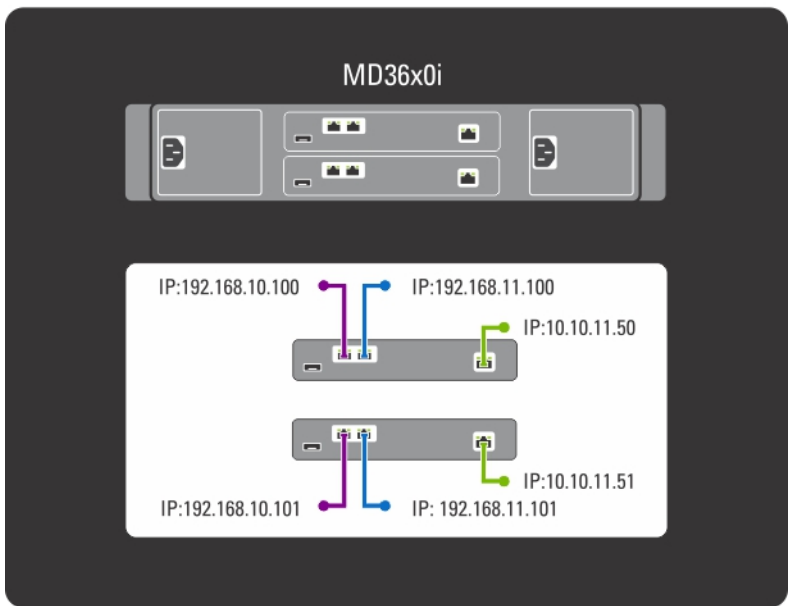
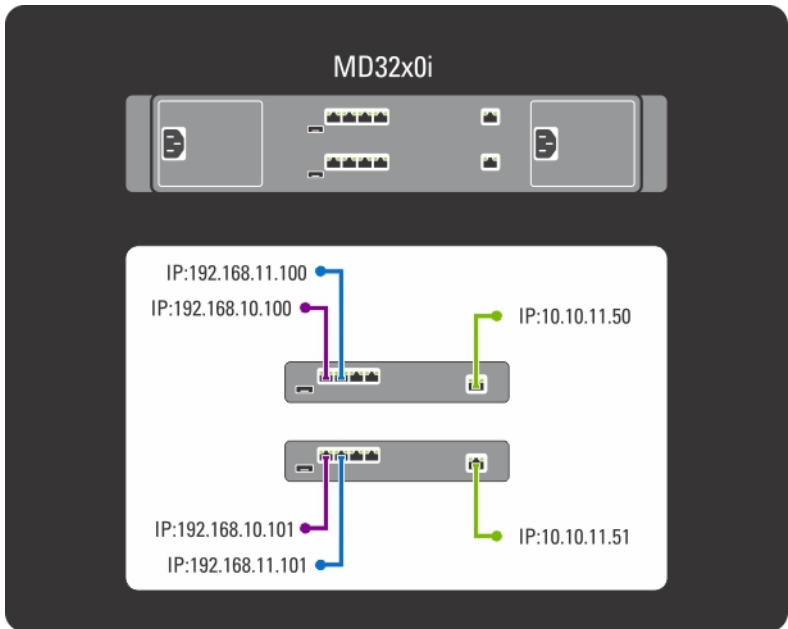

Figure 1. The MD Switch Topology

MD32x0i controllers have four iSCSI data ports. Note the following when configuring the ports:

- Ports 2 and 3 must not be configured on the same subnets as ports 0 and 1.
- Ports 2 and 3 can be used for additional block level iSCSI access by other hosts.

Choosing The Switch Topology

The PowerVault NX3600/NX3610 supports four switch topologies. The topologies are listed in the table with their benefits and challenges. Choose the ideal topology for your environment and cable the solution accordingly.

Table 1. Switch Topologies for PowerVault NX3600/NX3610 in the Non-Redundant and High Availability Options

| Topology | Description | High-Availability | Redundant | Number of Switches |
|--|---|-------------------|-----------|--------------------|
| Dedicated SAN — High Availability (HA) | This topology leverages the best practices of the industry relating to iSCSI and separates the SAN and LAN/Client traffic. The client cables are connected to a client switch and the SAN cables are connected to a SAN switch. | Yes | Yes | 4 |
| Dedicated SAN — Non-Redundant | | No | No | 2 |
| All-in-one solution — HA | A basic topology where the SAN and the client cables are connected to the same switch. | Yes | Yes | 2 |
| All-in-one solution — Non-Redundant | | No | No | |

Ensure the following settings are enabled in the SAN switch:

- Spanning Tree Portfast
- Flow control
- Jumbo frames (9000 MTU)

 **NOTE:** Dell PowerConnect switches need to be configured to 9216 MTU or greater to accept frames of size 9000 MTU. Non-Dell switches may require a different MTU configuration for similar frame sizes. For more information on MTU configuration for non-Dell switches, see the switch-specific manual.

 **NOTE:** Jumbo frames and flow control settings are mandatory for all ports used only by PowerVault NX3600/NX3610 and file access.

 **NOTE:** For the best practice solution in the HA option, connect the PowerVault NX3600/3610 and MD ports to the appropriate switch as shown in the following figure.

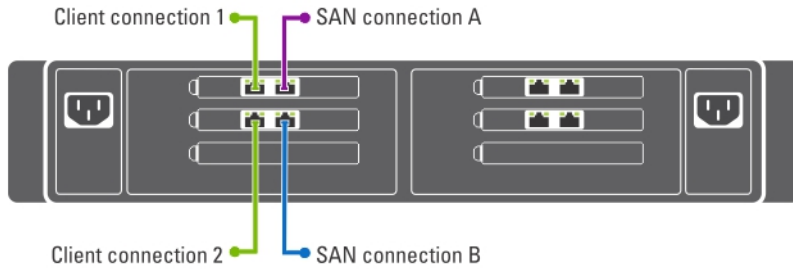

| PowerVault NX3600 | Controller 1 | Controller 2 |
|--------------------------|-------------------|-------------------|
| Client connection 1 | To client switch | To client switch |
| Client connection 2 | To client switch | To client switch |
| SAN connection A | To SAN switch (A) | To SAN switch (A) |
| SAN connection B | To SAN switch (B) | To SAN switch (B) |
| PowerVaultMDStorageArray | Connection | |
| Port 0 | To SAN switch (A) | |
| Port 1 | To SAN switch (B) | |

Figure 2. NX3600/NX3610 Controller NIC Cabling

NOTE:

- NX3600 supports one NAS appliance and one MD storage array.
- NX3610 supports up to two NAS appliances and two MD storage arrays.

Best Practice Solution In The HA Option

It is recommended to isolate the SAN traffic from the LAN or client traffic with redundant switches for HA. All the client cables are split between the redundant client switches, and the SAN or internal network cables are split between the redundant SAN switches. Peer connections are always back to back.

MD32x0i controllers have four iSCSI data ports. Note the following when configuring the ports:

- Ports 2 and 3 must not be configured on the same subnets as ports 0 and 1.
- Ports 2 and 3 can be used for additional block level iSCSI access by other hosts.

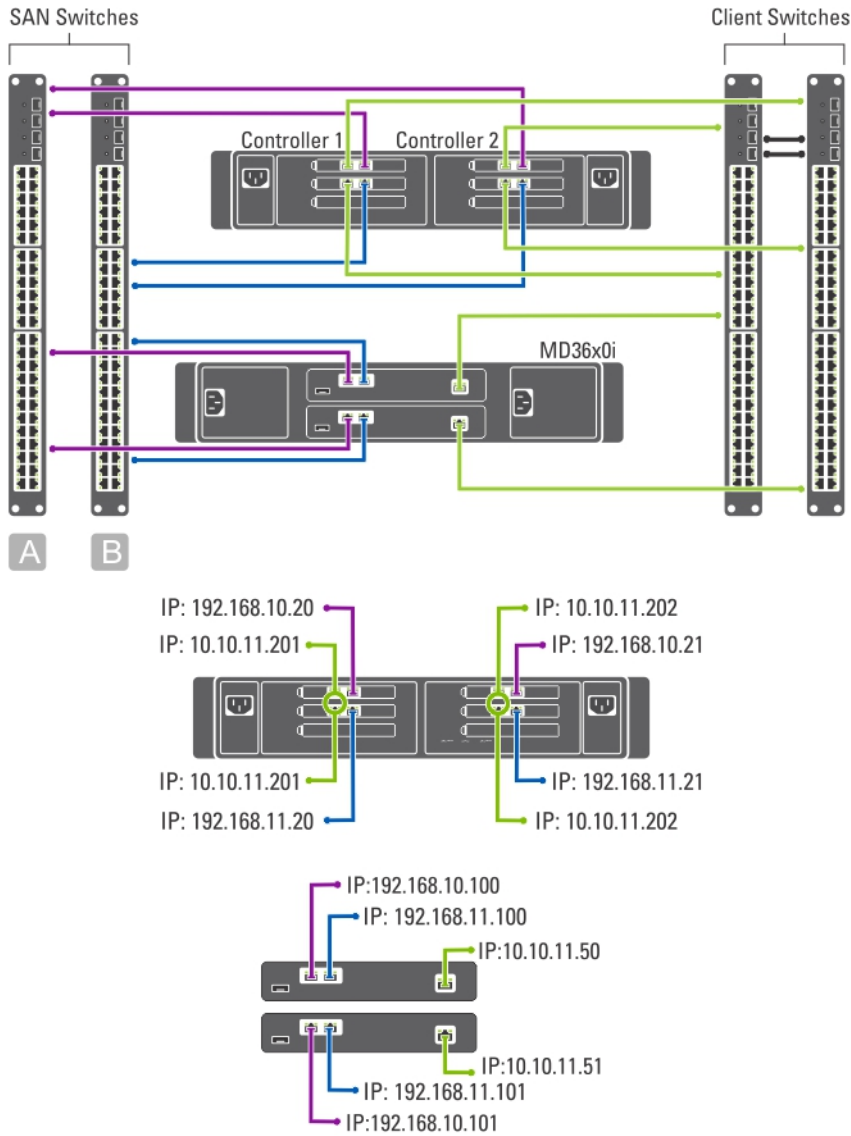

Figure 3. Dedicated SAN Solution in the High Availability Option

Dedicated SAN Solution In The Non-Redundant Option

The dedicated SAN solution in the non-redundant option isolates the SAN traffic from the client traffic, but without redundant switches. All the client cables are connected to the client switch and the SAN or internal network cables are connected to the SAN switch. Peer connections are always back to back.

CAUTION: In this configuration, the switches become a single point of failure.

NOTE: It is recommended that you separate the SAN subnets using virtual LANs.

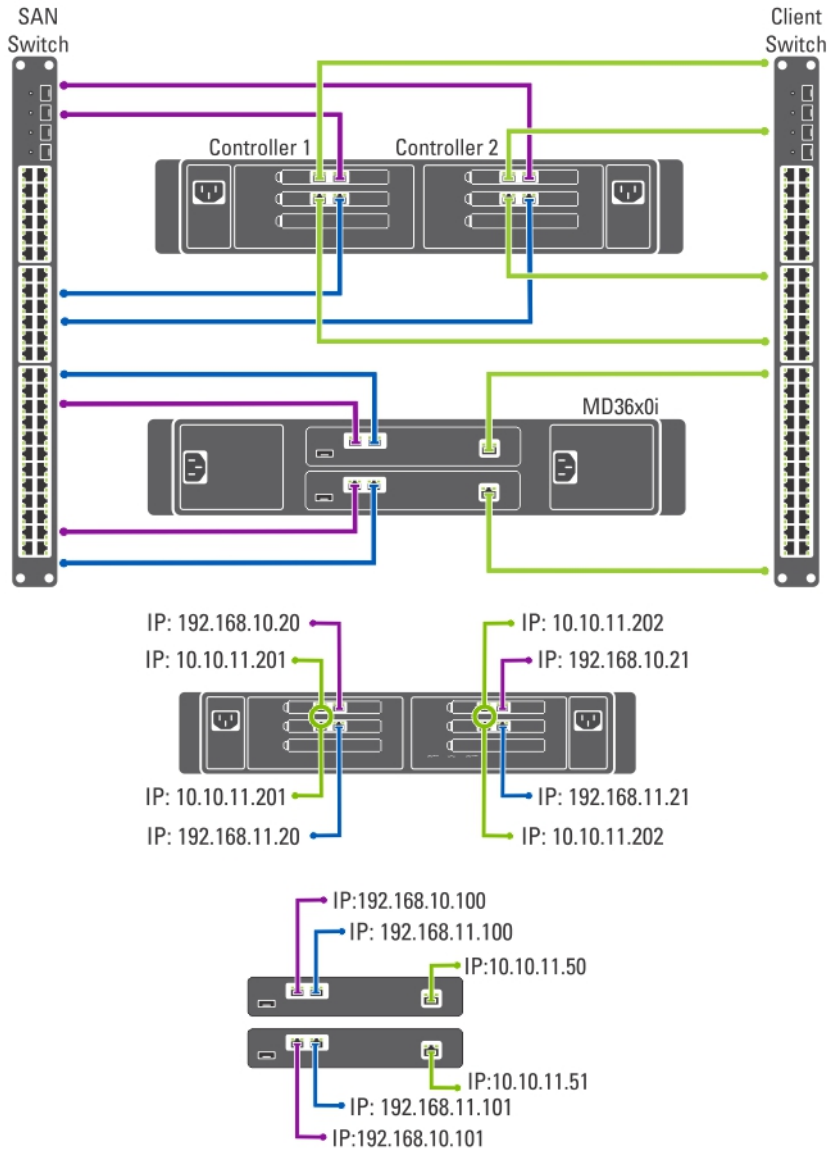

Figure 4. Dedicated SAN Solution in the Non-Redundant Option

All-In-One High-Availability Option

In an all-in-one high-availability option, the redundant switches host both SAN or internal and client network traffic. The SAN or internal and client cables are split between the redundant switches. Peer connections are always back to back.

NOTE: It is recommended that you separate the SAN subnets using virtual LANs.

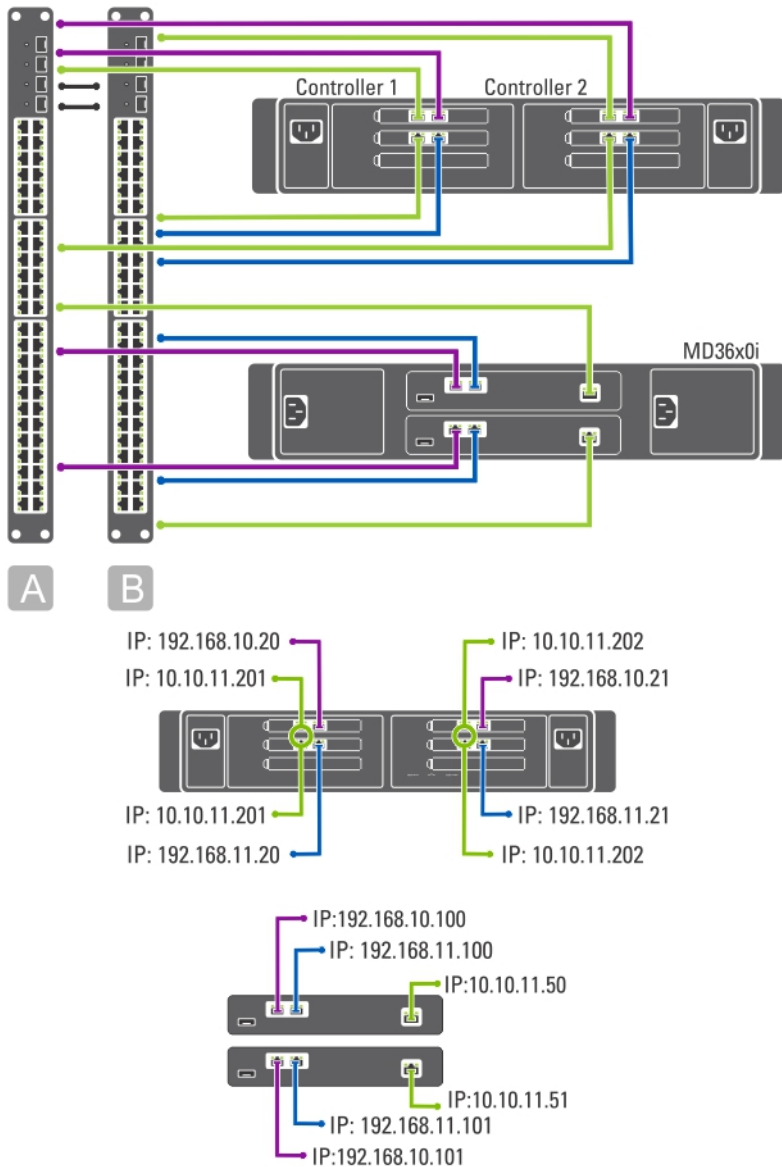

Figure 5. All-in-One High-Availability Option

All-In-One Non-Redundant Option

In an all-in-one non redundant option, both the SAN or internal and client cables are connected to the same switch.

CAUTION: In this configuration, the switch is a single point of failure.

NOTE: It is recommended that you separate the SAN subnets using virtual LANs.

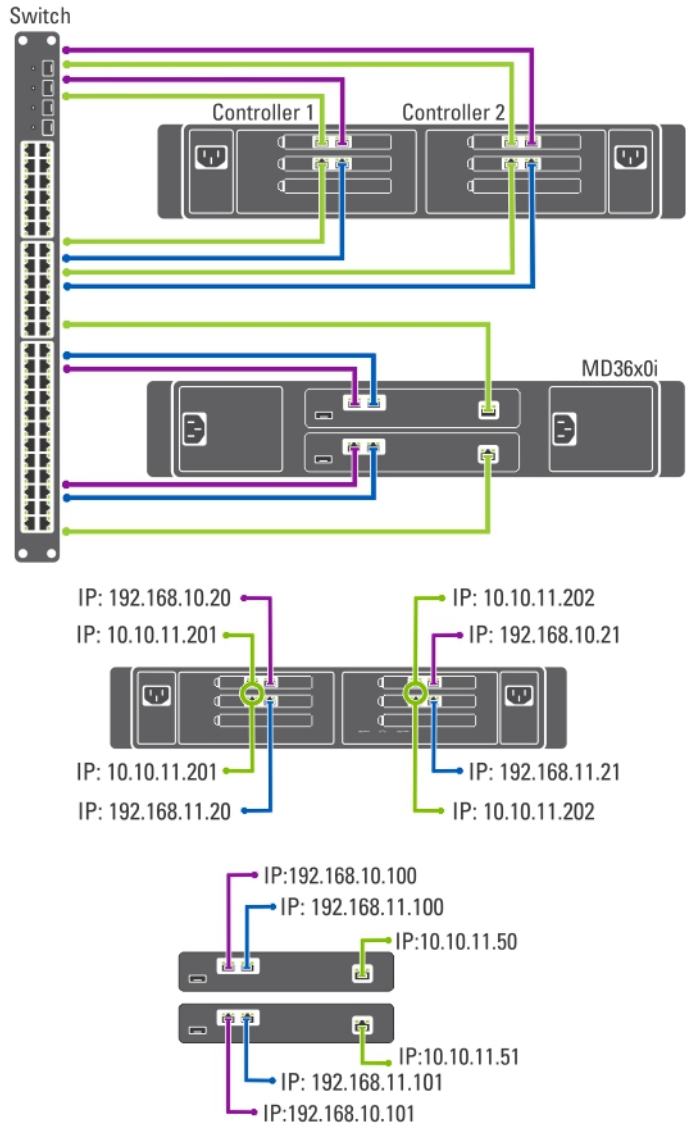

Figure 6. All-in-One Non-Redundant Option

Preparing Your Management Station

A management station is required to manage and configure the NAS cluster solution. The NAS cluster solution can be accessed using either the CLI or the Dell PowerVault NAS Manager.

NOTE: You can either log on to the CLI or the NAS Manager. It is highly recommended that you do not attempt to log on to both the CLI and NAS Manager at the same time.

The minimum requirements for the management station are as follows:

- IPv6 must be enabled.

- The NAS Initial Deployment Utility (IDU) must be installed.



NOTE: You can download and install the Dell NAS IDU from support.dell.com.

- The NAS cluster solution must be cabled appropriately and for the initial deployment, both the management station and NAS Appliance(s) must be connected to the same physical client or LAN switch.
- Either Microsoft Internet Explorer or Mozilla Firefox must be installed with JavaScript enabled.

Running The NAS IDU

The **Dell NAS Initial Deployment Utility (IDU)** guides you through the steps necessary to set up the network configuration and pair the controllers together. It also starts the process of pairing the system to the PowerVault MD32x0i storage appliance. It is recommended that you determine your network configuration and IP address allocation for your controllers before executing this utility.

Before running the NAS IDU, ensure that:

- The NAS IDU is installed and executed from a management station that has IPv6 enabled. The utility connects to and configures your controllers through the local link Ipv6 address. Ipv6 can be disabled, but only after the installation and configuration is complete.
- The management station is connected to the same switch as the client connections on your controllers (see the Switch Topologies for PowerVault NX3600/NX3610 table).

 **NOTE:** Use the NAS IDU only for initial configuration. After the NAS cluster solution is configured, use the NAS Manager to make changes to the configuration.

Installing The NAS IDU

To install the NAS IDU:

 **NOTE:** Before deploying the NAS IDU, ensure that IPv6 is enabled on all network interface devices connected to the Client or LAN switch(es).

1. Download the NAS IDU installer from support.dell.com.
2. Double-click on **FluidFS-NAS-IDU-installer.exe**.
The **NAS Deployment Utility** screen is displayed.
3. Follow the prompts in the installer to complete the installation.

Launching The NAS IDU

To launch the NAS IDU, select **Start** → **All Programs** → **Dell** → **FluidFS** → **NAS Deployment Utility**. The NAS IDU welcome screen is displayed.

 **NOTE:** The actual configuration is not applied until all settings are confirmed in the **Configuration Summary** screen.

 **NOTE:** Use this utility only to configure unconfigured appliances. Do not attempt to use this utility on fully configured or clustered PowerVault NX3600/NX3610 NAS solutions or to reconfigure IP addresses. This utility does not check for duplicate IPs or null entries.

Deploying The NAS Appliance Using The NAS IDU

To deploy the NAS appliance:

1. Launch the **NAS Deployment Utility**.

The **NAS Initial Deployment Utility Screen** is displayed.

2. Click **Next**.

The **NAS Discovery** screen is displayed.

- All un-configured NAS appliances are displayed in the **NAS Discovery** screen. Select the appropriate NAS appliance model and go to step 8.
- If un-configured NAS controllers are not discovered automatically, go to step 3.

3. On the **NAS Discovery** screen, click **Next**.

The **MAC Controller Discovery** screen is displayed.

4. Connect a monitor and keyboard to an un-configured controller.

The **Controller MAC Address** is displayed on the monitor that you connect to the controller.

5. On the **MAC Controller Discovery** screen, in **MAC Address**, enter the MAC address that is displayed on the monitor connected to the un-configured NAS controller.

6. Click **Connect** to test connection with the controller.

7. To change the entered MAC address, click **Edit**.

8. Click **Next**.

The **NAS Cluster Selection** screen is displayed. The **NAS Controller Discovery** screen displays the controllers of the un-configured NAS appliance, the service tag, and the status of the NAS appliance.

9. In the **NAS Cluster Selection** screen, click **Next**.

The **NAS Cluster Identification** screen is displayed.

10. In **NAS Cluster Name**, enter the name for the NAS cluster and click **Next**.

The **Network Configuration** screen is displayed.

11. Enter the following IP addresses:

- a) **Client VIP**
- b) **NAS Management VIP**
- c) **Gateway**
- d) **Subnet Mask**



NOTE: The IP addresses for the controllers are assigned automatically by using the Client VIP. For example, if the client VIP is set to *10.10.79.155*, the controller 0 IP will be *10.10.79.156* and so on.

12. From the **Interconnect Subnets** list, select a subnet that is not being used and does not conflict with any other subnet on your network.

If default subnets are not available, you can enter the IP address of the subnet manually.

13. You can assign the IP addresses of the controllers manually or allow the NAS IDU to automatically assign the IP addresses. To assign the IP addresses for the controllers manually, click **Advanced**.



NOTE: To allow the NAS IDU to assign the IP addresses automatically, click **Next**, the **NAS iSCSI network** screen is displayed. Proceed to step 9.

The **Client access network** screen is displayed.

a) Enter the IP address for each controller and click **Next**.

The **Management network** screen is displayed.

b) If blank, enter the IP addresses for the **Controllers**, **Winbind**, and **Subnet Mask**.



NOTE: If you select **Advanced** in the **Network Configuration** screen and enter the relevant IP addresses in the **Client access network** screen, the fields in the **Management network** screen are populated automatically.

c) Click **Next**.

The **Internal interconnect network** screen is displayed.

d) If blank, enter the IP addresses for the **Controllers**, **Winbind**, and **Subnet Mask**.

 **NOTE:** If you select **Advanced** in the **Network Configuration** screen and enter the relevant IP addresses in the **Client access network** screen, the fields in the **Management network** screen are populated automatically.

The **NAS iSCSI network** screen is displayed.

14. Enter the IP addresses for the following:

- **SAN Network A**
- **SAN Network B**
- **Subnet mask**

For SAN Networks A and B, enter the first IP address and as you enter the SAN network IP addresses the **IP Range for Controllers** get updated.

15. To modify the **IP Range for Controllers**, click **Modify** and modify the IP addresses manually.

16. From the **Network MTU list**, select the appropriate MTU.

 **NOTE:** In most cases, the required MTU is 9000.

17. Click **Next**.

The **iSCSI Target Discovery** screen is displayed.

18. In **iSCSI Discovery Address for MD Array**, enter one of the IP addresses for the iSCSI target.

19. Click **Next**.

 **NOTE:** It is highly recommended to copy the configuration details from the **Configuration Summary** screen and paste it in a different file (.doc or .txt) for future reference.

The **Configuration Summary** screen displays all the configuration details for the selected NAS appliance.

20. Click **Next**.

The NAS IDU applies the cluster configuration to the selected NAS appliance. After the configuration is complete, the **Configuration Results** screen is displayed. The NAS controller IQNs are displayed in the **Configuration Results** screen.

 **NOTE:** It is highly recommended to copy the NAS controller IQN details from the **Configuration Results** screen and paste it in a different file (.doc or .txt) for future reference. You must match these NAS controller IQNs in the MDSM.

21. Set up your MD storage array using MDSM.

For more information, see **Setting Up Your MD Storage Solution**.

22. Click **Finish**.

Setting Up Your MD Storage Solution

This section assumes you have discovered and completed the initial configuration (naming, assigning iSCSI, and management port IPs) of your PowerVault MD32x0i/MD36x0i storage arrays in accordance with the topology you plan to use.

This section provides the steps necessary to configure the host group and virtual disks that are required for the NAS cluster solution. For additional information regarding a task such as creating virtual disks, see the PowerVault Modular Disk Storage Manager (MDSM) Help or the Dell PowerVault MD32x0i Owner's Manual at support.dell.com/manuals.

 **CAUTION:** Correctly preparing the PowerVault Modular Disk (MD) storage array is critical for successfully configuring your NAS solution.

 **NOTE:** It is highly recommended that you set up SMTP email alerts on the MD-Series array to be cautioned in case of failures that can impact data availability.

 **NOTE:** PowerVault MDSM is available for download on support.dell.com.

 **NOTE:** See the MD storage array documentation at support.dell.com/manuals.

 **NOTE:** Additional configuration is required after completing the steps in the PowerVault Configuration Utility. Challenge Handshake Authentication Protocol (CHAP) must be disabled on the PowerVault MD32x0i storage array and the storage array must be configured for two logical SANs.

Use the PowerVault MDSM to complete the following tasks:

1. Create disk groups.

 **NOTE:** It is recommended that you create a disk group for each virtual disk. However, you can create multiple virtual disks in a disk group.

2. Create virtual disk pairs.
3. Create hosts and host group.
4. Map the virtual disks to the host group.

Creating Disk Groups

You can create disk groups either:

- Automatically
- Manually

Creating Disk Groups Automatically

To create disk groups automatically:

1. Launch the PowerVault MDSM software on the management station.
2. Select the MD storage array you plan to use for your NAS storage.
See the Dell PowerVault MD32x0i storage array Deployment Guide at support.dell.com/manuals.

3. Start the **Create Disk Group Wizard** using one of the following methods:
 - a) On the **Logical** tab, select **Unconfigured Capacity**, or right-click **Unconfigured Capacity** and select **Create Disk Group** from the pop-up menu.
 - b) On the **Physical** tab, select one or more unassigned physical disks of the same physical disk type, or right-click the unassigned physical disks and select **Create Disk Group** from the pop-up menu.

The **Introduction (Create Disk Group)** window is displayed.

4. In the **Introduction (Create Disk Group)** window, click **Next**.

The **Disk Group Name & Physical Disk Selection** window is displayed.

5. Type a name for the disk group in **Disk Group Name**.

It is recommended that you use the name of the NAS cluster appended by disk group and number for the disk group name. For example, *NX3600-Disk-Group-0*.

 **NOTE:** The disk group name must not exceed 30 characters.

6. In **Physical Disk selection**, select **Automatic** and click **Next**.

7. In the **RAID Level and Capacity** window, select the appropriate RAID level from the **RAID level** list.

You can select RAID levels 1/10, 5, or 6. Depending on the RAID level chosen, the physical disks available for the selected RAID level are displayed in **Select Capacity** table.

8. In the **Select Capacity** table, select the relevant disk group capacity, and click **Finish**.

The **Disk Group Created** screen is displayed. If you are going to use two disk groups, repeat the procedure and then proceed to Creating Virtual Disks.

Creating Disk Groups Manually

To create disk groups manually:

1. Launch the PowerVault MDSM software on the management station.
2. Select the MD storage array you plan to use for your NAS storage.
See the Dell PowerVault MD32x0i storage array Deployment Guide at support.dell.com/manuals.
3. Start the **Create Disk Group Wizard** using one of the following methods:
 - On the **Logical** tab, select **Unconfigured Capacity**, or right-click **Unconfigured Capacity** and select **Create Disk Group** from the pop-up menu.
 - On the **Physical** tab, select one or more unassigned physical disks of the same physical disk type, or right-click the unassigned physical disks and select **Create Disk Group** from the pop-up menu.

The **Introduction (Create Disk Group)** window is displayed.

4. In the **Introduction (Create Disk Group)** window, click **Next**.

The **Disk Group Name & Physical Disk Selection** window is displayed.

5. Type a name for the disk group in **Disk group name**.

It is recommended that you use the name of the NAS cluster appended by disk group and number for the **Disk group name**. For example, *NX3600-Disk-Group-0*.

 **NOTE:** The disk group name must not exceed 30 characters.

6. In **Physical Disk selection** choices, select **Manual** and click **Next**.

7. In the **RAID Level and Capacity** window, select the appropriate RAID level from the **RAID level** list.

You can select RAID levels 1/10, 5, or 6. Depending on the RAID level chosen, the physical disks available for the selected RAID level are displayed in **Unselected Physical Disks** table.

8. In the **Unselected Physical Disks** table, select the relevant disk group capacity, and click **Add**.

 **NOTE:** You can select multiple physical disks at the same time by holding **Ctrl** or **Shift** and selecting additional physical disks.

To view the capacity of the new disk group, click **Calculate Capacity**.

9. Click **Finish**.

The **Disk Group Created** screen is displayed. If you are going to use two disk groups, repeat step 3 to step 9 and then proceed to Creating Virtual Disks.

Creating Virtual Disks

 **NOTE:** Create a minimum of two virtual disks of the same size dedicated for the NAS storage. The NAS storage capacity can be expanded to up to 16 virtual disks and the number of virtual disks must increment in pairs.

 **NOTE:** Minimum and maximum virtual disk size required for the PowerVault NX3600/NX3610 is 125 GB and 15 TB respectively.

 **NOTE:** If you select **Yes** in the **Disk Group Created** screen while creating disks manually or automatically, the **Introduction (Create Virtual Disk)** screen is displayed. Proceed to step 4.

To create virtual disks:

1. Access the **PowerVault MDSM**.

2. Click **Virtual Disk** in the top menu.

3. Click **Create**.

The **Introduction (Create Virtual Disk)** screen is displayed.

4. Click **Next**.

The **Specify Capacity/Name** screen is displayed.

5. In **New virtual disk capacity**, enter the size of the virtual disk.

 **NOTE:** The size of the virtual disk must be equal to or less than the free capacity.

6. Enter a relevant name for the virtual disk in the **Virtual Disk name** field.

7. Select **Use recommended settings**.

8. Click **Finish**.

The **Create Successful (Create Virtual Disk)** screen is displayed.

9. Click **Yes** to create a new virtual disk.

The **Allocate Capacity (Create Virtual Disk)** screen is displayed.

10. Repeat step 5 to step 8 to create the second virtual disk. The disk size must be the same as the first virtual disk.

Creating A Host Group

To create a host group:

1. Launch the PowerVault MDSM and target the MD storage array you plan to use for your NAS storage.

2. Select the **Mappings** tab.

3. In the **Topology** pane, select the storage array or the **Default Group**.

4. Perform one of the following actions:

- Select **Mappings** → **Define Host Group**.

- Right-click the storage array or the **Default Group**, and select **Define Host Group** from the pop-up menu.

The **Define Host Group** screen is displayed.

5. Type the name of the new host group in **Enter New Host Group Name** (for example, PowerVault_NX3600).

 **NOTE:** Host group name must have 30 alphanumeric characters.

 **NOTE:** No host other than the NX3600/NX3610 controllers must be added to this host group.

6. Click **OK**.

The mappings are saved. The **Topology** pane and the **Defined Mappings** pane in the **Mappings** tab are updated to reflect the mappings.

Creating A Host

To create a host in the host group you created:

1. Right-click the host group you created.
2. Click **Define** → **Host**.
The **Specify Host Name (Define Host)** screen is displayed.
3. Type the name of the new host in **Host name**.
4. Click **Next**.
The **Specify Host Port Identifiers (Define Host)** screen is displayed.
5. Select the host port identifier from the **Add by selecting a known unassociated host port identifier** list.
6. Type the host name in **User label** and suffix the host name with IQN.
7. Click **Add**.
8. Click **Next**.
The **Specify Host Type (Define Host)** screen is displayed.
9. Select **Linux** from the **Host type (operating system)** list.
10. Click **Next**.
The **Preview (Define Host)** screen is displayed.
11. Click **Finish**.
The **Creation Successful (Define Host)** screen is displayed.
12. Click **Yes** to define another host.
Repeat step 2 to step 10 to create another host.

Adding Virtual Disks To A Host Group

To add virtual disks to a host group:

1. Right-click the host group you created.
2. Click **Define** → **Additional Mapping**.
The **Define Additional Mapping** screen is displayed.
3. In **Host group or host**, select the host group you created in the previous steps.
4. In the **Logical Unit Number** field, select a LUN. The supported LUNs are 0 through 255.
5. In the **Virtual Disk** field, select the first virtual disk that you created.
6. Click **Add**.
The virtual disk you selected is added and the **Logical unit number (LUN) (0–255)** list is populated.
7. Select the second virtual disk from the **Virtual Disk** list.
8. Click **Add**.

The second virtual disk you selected is added and the **Logical unit number (LUN) (0–255)** list is populated.

9. Click **Close**.

Creating Host-To-Virtual Disk Mappings

To create host-to-virtual disk mappings:

1. Launch PowerVault MDSM and target the MD storage array you plan to use for your NAS storage.
2. In the **Topology** pane, expand **Default Group** and select the host group you created.
3. Right-click the host group and select **Define** → **Host**.
The **Specify Host Name (Define Host)** screen is displayed.
4. Type the name of the host in **Host name** (for example, *NX3600_Controller_0*) and click **Next**.
The **Specify Host Post Identifier (Define Host)** screen is displayed.
5. In the **Specify Host Post Identifier (Define Host)** screen, select the IQN of Controller 0 from the **Known unassociated host port identifier** list.
6. Type a name in **User Label** (for example, *NX3600_Controller_0_IQN*) and click **Add**.
The **Host Port Identifier** and **Alias / User Label** values are added.
7. Click **Next**.
The **Specify Host Type** screen is displayed.
8. Select **Linux** from the **Host type (operating system)** list.
The **Preview (Define Host)** screen is displayed.
9. Click **Finish**.
The **Creation Successful (Define Host)** screen is displayed.
10. Click **Yes** to define another host.

 **NOTE:** Repeat step 4 to step 10 for Controller 1.

11. In the **Topology** pane, expand **Default Group** and select the host group you created in the previous steps.
12. Right-click the host group and select **Define** → **Additional Mapping**.
The **Define Additional Mapping** screen is displayed.
13. In **Host group or host**, select the host group you created in the topic “Creating A Host Group”.
14. In the **Logical Unit Number** field, select a LUN. The supported LUNs are 0 through 255.
15. In the **Virtual Disk** field, select the first virtual disk that you created.
16. Click **Add**.

 **NOTE:** The **Add** button is inactive until a host group or host, LUN, and virtual disk are selected.

 **NOTE:** After a virtual disk has been mapped, it is no longer available in the virtual disk area.

17. Click **Close**.
The mappings are saved. The **Topology** pane and the **Defined Mappings** pane in the **Mappings** tab are updated to reflect the mappings.

Accessing The NAS Manager Web Interface

To access the NAS Manager:

1. Access the PowerVault NAS Manager web interface using the NAS Management VIP address you specified in the NAS IDU.

 **NOTE:** The **Security Alert** window is displayed after you install the PowerVault NAS cluster solution, or after upgrading the system. Clicking **Yes** enables the current session. Clicking **View Certificate**, as explained in the following step, enables all future sessions.

The **Security Alert** window is displayed.

2. Click **View Certificate**.

3. Click **Install Certificate**.

The **Certificate Import Wizard** is displayed.

4. Click **Next**.

The **Certificate Store** screen is displayed.

5. Verify that **Automatically select the certificate store based on the type of certificate** is selected and click **Next**.

The **Completing the Certificate Import Wizard** screen is displayed.

6. Click **Finish**.

A message prompts you that the certificate is imported successfully.

7. Click **OK**.

The certificate window is displayed.

8. In the **Certificate** window, click **OK**.

9. Access the NAS Manager.

 **NOTE:** This window is displayed only if the license has not been installed.

The **PowerVault License file** window is displayed.

10. Browse to the **License file** and click **Install**.

11. Type the **username** and **password** and click **Log in**.

 **NOTE:** Use **admin** as the username. The default password is **Stor@ge!**. You have the option of changing the password later.

 **NOTE:** If the Start Configuration page does not open automatically, click **System Management** → **Maintenance Start Configuration Wizard** .

NAS Manager Configuration Wizard

The **NAS Manager Configuration Wizard** helps complete the PowerVault NAS cluster solution configuration and integrate the solution into the environment. You can set up the DNS, time management, user identification, authentication parameters, and monitoring options as well as formatting and starting the file system.

You can leave the wizard at any time by selecting another page from the navigation pane. Every page in the configuration wizard can also be accessed from the navigation pane. This means that you can modify the system's configuration parameters directly, by accessing the appropriate page from the navigation pane, without having to run the entire wizard.

 **NOTE:** The **Start Configuration Wizard** in the **NAS Manager** opens automatically when you click **Finish** in the **NAS IDU**.

To configure the NAS solution using the **NAS Manager Configuration Wizard**:

1. Launch the **PowerVault NAS Manager**.
2. Select **Start Configuration Wizard** from the navigation pane.
The **Configuration Wizard (DNS Configuration) step 1 of 14** screen is displayed.
3. Enter appropriate values in **DNS server** and **DNS suffix**.

 **NOTE:** You can add additional DNS servers and DNS suffixes by clicking **Add DNS server** and **Add DNS suffix**.

4. Click **Next**.
The **Configuration Wizard (Time Configuration) step 2 of 14** screen is displayed.
5. Select the appropriate **Time zone** from the list.
6. Select **Time should be synchronized with an NTP server** and enter the **NTP server** address.

 **NOTE:** It is highly recommended that you use an NTP server. If the clients and the NAS cluster get out of sync for more than five minutes, the clients are not be able to connect to the cluster.

7. Click **Next**.
The **Configuration Wizard (E-mail Configuration) step 3 of 14** screen is displayed.

 **NOTE:** It is highly recommended that you configure an SMTP server for e-mail alerts in case of issues with the cluster solution.

8. Click **Add SMTP server**.
The Configuration Wizard (Add SMTP server) step 3 of 14 screen is displayed.
9. In **SMTP Server**, add the SMTP server address.
10. In **Description**, enter the description for the SMTP server and click **Save Changes**.

 **NOTE:** If your SMTP server requires authentication, enter the **User name** and **Password** to access the SMTP server.

The **Configuration Wizard (SNMP Configuration) step 4 of 14** screen is displayed.

11. Enter appropriate values for the following:
 - a) **System contact**
 - b) **System location**

- c) **Read community**
- d) **Trap recipient**

 **NOTE:** Click **Add** to add multiple **Trap** recipients.

12. Click **Next**.

The **Configuration Wizard (File System Formation) step 5 of 14** screen is displayed.

13. Click **Next**.

The following message is displayed: **Are you sure you want to format the file system?**

14. Click **OK**.

A message confirming that the file system has been formatted is displayed.

15. Click **Next**.

The **Configuration Wizard (System Stop/Start) step 6 of 14** screen is displayed.

 **NOTE:** Ensure that LUNs are assigned for each controller.

16. To format the LUNs, click **Next**.

The **Configuration Wizard (Change Passwords) step 7 of 14** screen is displayed.

You can create a new CIFS Administrator password and change the default admin password in this screen.

 **NOTE:** To change the admin password or the CIFS Administrator password, you must enter the default admin password. The default admin password is **Stor@ge!**.

17. Click **Next**.

The **Configuration Wizard (System Identity) step 8 of 14** screen is displayed.

18. Select **The system is a member in a Microsoft Windows network** to connect the file system to a Windows active directory.

19. Enter appropriate values for the following:

- a) **System NetBIOS name**
- b) **Domain**
- c) **User name**
- d) **Password**

 **NOTE:** The credentials you enter for **User name** and **Password** must have domain administrator rights to join the domain.

20. Click **Next**.

The following message is displayed: **Saving changes will cause CIFS clients to be disconnected. Do you wish to continue?**

21. Click **OK**.

The **Configuration Wizard (CIFS Protocol Configuration) step 9 of 14** screen is displayed.

22. Select **Allow clients to access files via the CIFS protocol** and enter an appropriate description in **System description**.







23. Select **Authentic users' identity via Active Directory and local users database** to configure the Active Directory security mode.

24. Click **Next**.

The **Configuration Wizard (Identity Management Database) step 10 of 14** screen is displayed.

25. Enter appropriate values for the following:

- a) **Domain name**
- b) **NIS server**
- c) **LDAP Server**
- d) **Base DN**

26. Click **Next**.
The **Configuration Wizard (Cross-protocol User Mapping) step 11 of 14** screen is displayed.
27. To automatically map users in Active Directory to users in the UNIX user repository, select **Map users in Active Directory to users in the UNIX repository automatically**.
 **NOTE:** By default, **Map unmapped users to the guest account** is selected.
28. Click **Next**.
The **Configuration Wizard (NAS Volumes Configuration) step 12 of 14** screen is displayed.
29. Click **Add** to define NAS volumes.
30. Enter appropriate values for the following:
 - a) **NAS Volume**
 - b) **NAS volume allocated space**
 - c) **Alert when used space reaches**
 - d) **Send email events to administrator**
 - e) **Access time granularity**
 **NOTE:** The file access security style must be set to default **NTFS**.
31. Click **Save Changes**.
The new NAS volume is added.
 **NOTE:** Repeat step 29 to step 31 to define more NAS volumes.
32. Click **Next**.
The **Configuration Wizard (Add CIFS Shares) step 13 of 14** screen is displayed.
33. Select the volume from the **NAS Volume** list to add CIFS Share.
34. Select **General-access share** and enter the **Share name** and **Directory**.
 **NOTE:** You are not able to add a CIFS share if a shared folder is not created.
35. Click **Save Changes**.
A CIFS share is created and the **Configuration Wizard (CIFS Shares) step 13 of 14** screen is displayed.
 **NOTE:** Click **Add** and repeat step 32 to step 35 to add more CIFS shares to a NAS volume.
36. Click **Next**.
The **Configuration Wizard (NFS Exports) step 14 of 14** screen is displayed.
 **NOTE:** You must create an NFS export only if you have a UNIX client.
37. If you have a UNIX client, click **Add** otherwise click **Next** and skip to step 44.
 **NOTE:** You can create new NFS export directory in the existing NAS volumes or use an existing shared folder as an NFS export.
38. Select the volume from the **NAS Volume** list.
39. To create an NFS export from an existing shared folder, click the **Browse icon** and navigate to the appropriate folder and select the directory from the **Exported directory** list.
40. To create a new NFS export, in **Exported directory** enter the name for the NFS export. Select **Create the exported directory if it does not exist**.
41. Define the client machines that are allowed access to the NFS export by selecting one of the following:
 - a) **All Client Machines**
 - b) **A single Client Machine**
 - c) **All Client Machines in a specific network**
 - d) **All Client Machines in a specific netgroup**
42. Click **Save Changes**.

The **Configuration Wizard (NFS export) step 14 of 14** screen with the existing NFS exports is displayed.

43. To add additional NFS exports, click **Add** and repeat step 38 to step 41.

44. Click **Next**.

The system **Configuration Wizard** is complete.

Configuring Additional Client VIPs

NOTE:

- If the client network is routed to get to the FluidFS cluster, one client VIP is needed for each port. Each appliance can have up to four VIPs.
- If the client network is not routed to get to the FluidFS cluster, only one client VIP is needed.

To configure additional client VIPs:

- 1.** Select **Cluster Management** → **Network** → **Subnets**.
The **Subnets** screen displays all the available subnets.
- 2.** Click the **Primary** subnet.
The **Add/Edit Subnet** screen is displayed.
- 3.** In **VIP address**, add additional client VIP addresses, as required.

 **NOTE:** If you need more than four VIPs, click **Add VIP**.

- 4.** Click **Save Changes**.

PowerVault FluidFS NAS Setup Worksheet

Complete the worksheet to record the layout of your PowerVault FluidFS NAS.

| | | | | | |
|--------------------------|----------------------------|----------------------------|----------------------------|-----------------|---------------------------------|
| Number of NAS Appliances | <input type="checkbox"/> 1 | Number of MD-Series Arrays | <input type="checkbox"/> 1 | Type of Network | <input type="checkbox"/> Routed |
| | <input type="checkbox"/> 2 | | <input type="checkbox"/> 2 | | <input type="checkbox"/> Flat |
| NAS Cluster Name: | | Subnet Mask | | Gateway | |

| Primary Client Network | |
|------------------------|--|
| Management VIP: | |
| NAS Appliance 0 | |
| Controller 0 IP | |
| Controller 1 IP | |
| NAS Appliance 1* | |
| *Controller 2 IP | |
| *Controller 3 IP | |

| iSCSI SAN Network | | |
|-------------------|-------|-------|
| Controller | SAN A | SAN B |
| Controller 0 | | |
| Controller 1 | | |
| *Controller 2 | | |
| *Controller 3 | | |

| Client VIPs | |
|---|--|
| Flat Network needs only 1 VIP. Routed Networks need 4 VIPs per Appliance. | |
| 1 Appliance = 4; *2 Appliances = 8 | |
| Client VIP # 1 | |
| Client VIP # 2 | |
| Client VIP # 3 | |
| Client VIP # 4 | |
| *Client VIP # 5 | |
| *Client VIP # 6 | |
| *Client VIP # 7 | |

| MD-Series iSCSI Discovery Address | | |
|-----------------------------------|-------------------|--|
| Array #1 | Management | |
| Controller 0-0 | SAN A- | |
| Controller 0-1 | SAN B- | |
| Controller 1-0 | SAN A- | |
| Controller 1-1 | SAN B- | |

| Array #2 | Management | |
|-----------------|-------------------|--|
| Controller 0-0 | SAN A- | |
| Controller 0-1 | SAN B- | |
| Controller 1-0 | SAN A- | |
| Controller 1-1 | SAN B- | |

*Client VIP # 8

Use one IP for iSCSI Discovery in NAS IDU

| Environment Setup | | | | | |
|--------------------------|--|-------------------------|--|-------------------------|--|
| DNS Server IP | | SNMP Read Community | | NIS Domain | |
| DNS Suffix | | SNMP Trap Recipient | | NIS Server | |
| NTP Server IP | | NetBIOS Name | | LDAP Server | |
| SMTP Server IP | | Active Directory Domain | | LDAP Distinguished Name | |
| SMTP From E-mail Address | | | | | |

I

| Interconnect Private Network |
|--|
| Select a private Class C subnet |
| <input type="checkbox"/> 10.255.254.x |
| <input type="checkbox"/> 172.31.254.x |
| <input type="checkbox"/> 192.168.254.x |
| <input type="checkbox"/> _____.____.____.x |

| Switch Requirements Checklist | | |
|-------------------------------|--------------------------------------|-----------------------------------|
| | Client Network | SAN/Internal Network |
| Jumbo Frames Enabled 9216 MTU | <input type="checkbox"/> Recommended | <input type="checkbox"/> Required |
| Port Fast Enabled | <input type="checkbox"/> Required | <input type="checkbox"/> Required |
| Flow Control Enabled | <input type="checkbox"/> Recommended | <input type="checkbox"/> Required |

*Applicable only to NX3610.

Getting Help

Contacting Dell

 **NOTE:** If you do not have an active Internet connection, you can find contact information on your purchase invoice, packing slip, bill, or Dell product catalog.

Dell provides several online and telephone-based support and service options. Availability varies by country and product, and some services may not be available in your area. To contact Dell for sales, technical support, or customer service issues:

1. Visit support.dell.com.
2. Select your support category.
3. If you are not a U.S. customer, select your country code at the bottom of the support.dell.com page, or select **All** to see more choices.
4. Select the appropriate service or support link based on your need.